

HEAVY DUTY AIR DIE GRINDER

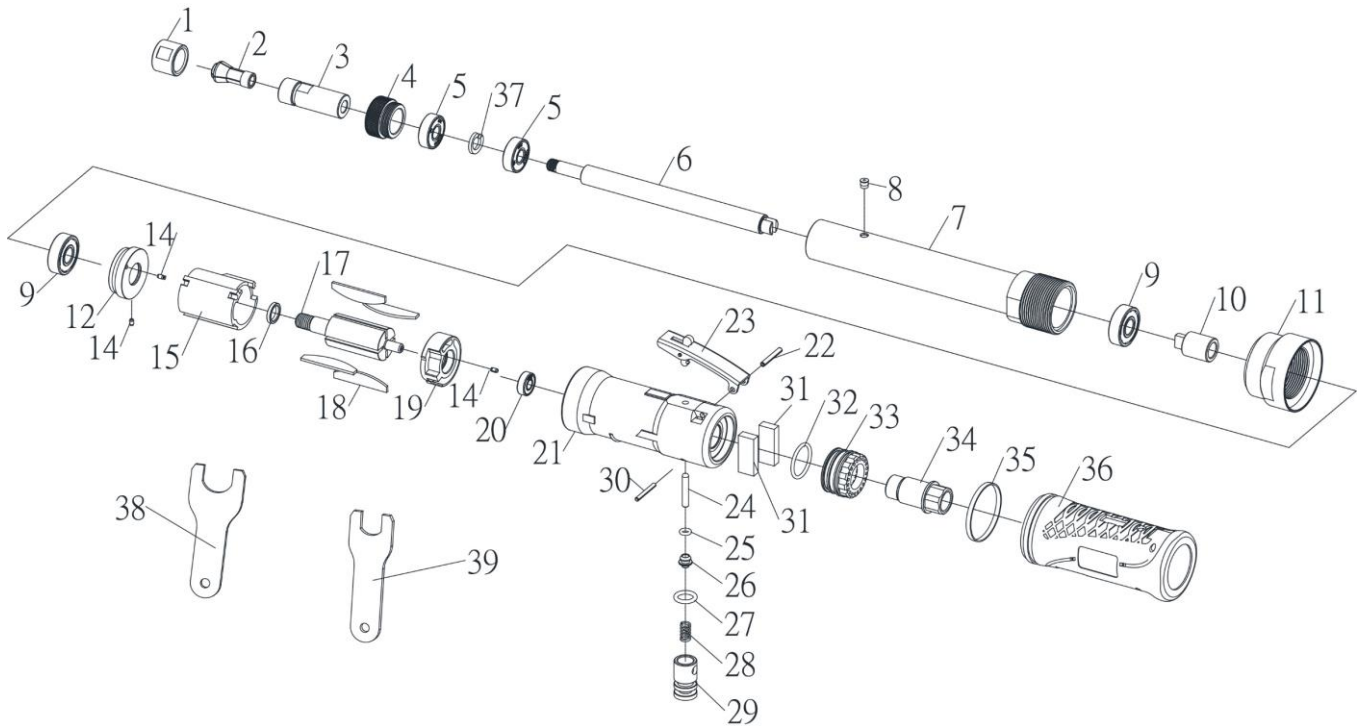

6242-7L

INDEX NO.	DESCRIPTION	REQ'D NO.	INDEX NO.	DESCRIPTION	REQ'D NO.
01	Collet Nut	1	21	Motor Housing	1
02	1/4" Collet	1	22	Spring Pin	1
	6mm Collet		23	Safety Lever	1
03	Spindle	1	24	Valve Shaft	1
04	Lock Ring	1	25	O-Ring	1
05	Ball Bearing	2	26	Throttle Valve	1
06	Shaft Coupling	1	27	O-Ring	1
07	Retaining Bar	1	28	Valve Spring	1
08	Grease Fitting 3/16"	1	29	Air Regulator	1
09	Ball Bearing	2	30	Spring Pin	1
10	Drive Shaft	1	31	Muffler	2
11	Coupling Nut	1	32	O-Ring	1
12	Front End Plate	1	33	Exhaust Sleeve	1
14	Spring Pin	3	34	Inlet Bushing	1
15	Cylinder	1	35	Rubber Band	1
16	Washer	1	36	Housing Cover	1
17	Rotor	1	37	Washer	1
18	Rotor Blade	4	38	#19mm Spanner	1
19	Rear End Plate	1	39	#14mm Spanner	1
20	Ball Bearing	1			

0000.00.00

2015.01.21 2016.10.21