

1/4"SQ.DR. HEAVY DUTY MINI RATCHET WRENCH

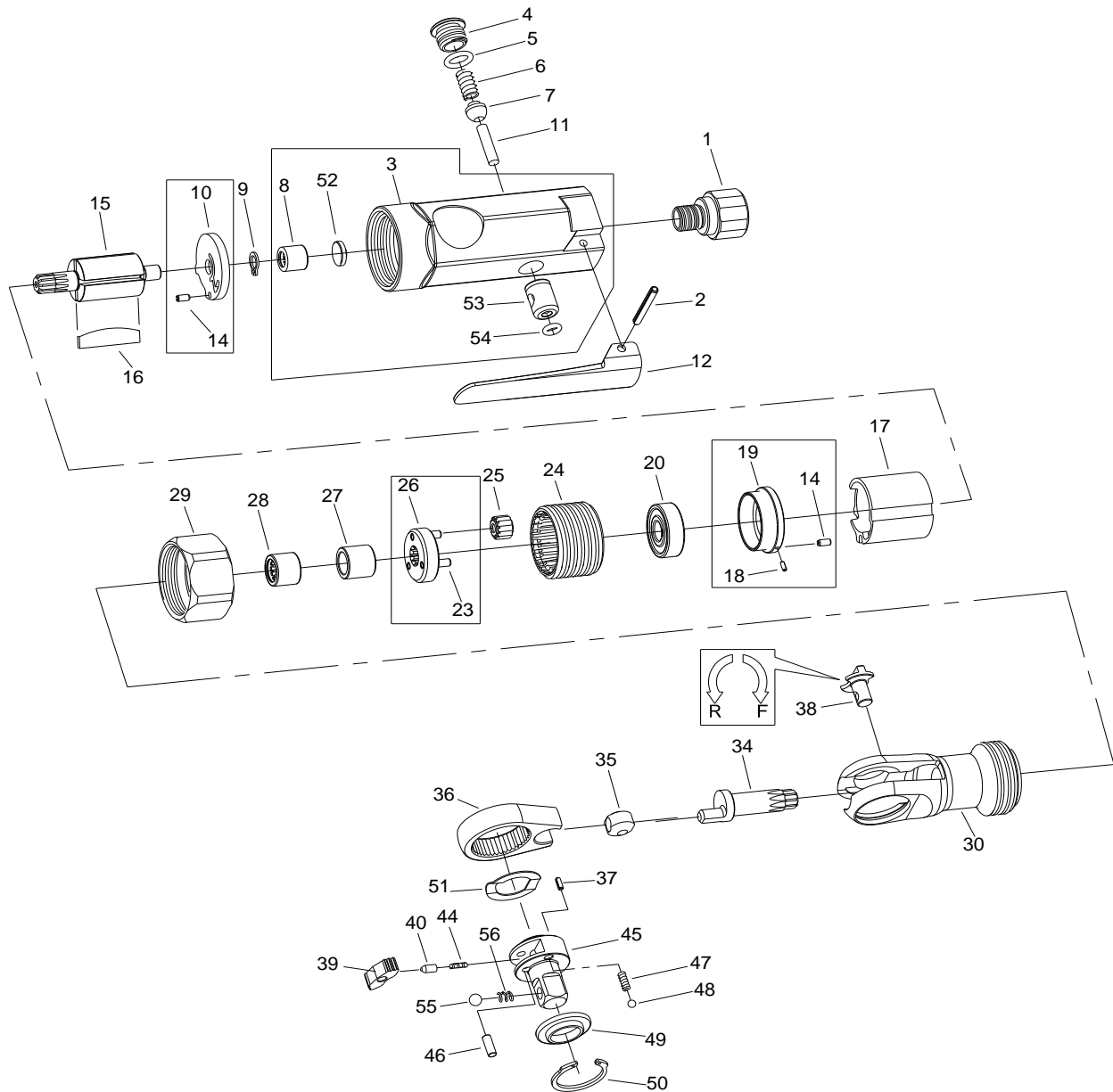

218

INDEX NO.	DESCRIPTION	REQ'D NO.	INDEX NO.	DESCRIPTION	REQ'D NO.
1	Air Inlet	1	● 28	Needle Bearing	1
2	Trigger Pin	1	29	Coupling Nut	1
★ 3	Housing Assembly (incl.8.52.53.54)	1	★ 30	Ratchet Housing Assembly (incl.27.28)	1
4	Air Regulator	1	34	Crank Shaft	1
5	O-Ring	1	35	Drive Bushing	1
6	Spring	1	36	Ratchet Yoke	1
7	Throttle Valve	1	● 37	Spring Pin	1
● 8	Needle Bearing	1	38	Reverse Knob	1
9	Retainer	1	39	Ratchet Pawl	1
★ 10	Rear End Plate Assembly { incl.14 (1) }	1	40	Ratchet Lock Pin	1
11	Valve Pin	1	44	Ratchet Spring	1
12	Trigger	1	★ 45	Ratchet Anvil Assembly (incl.37.55.56)	1
● 14	Spring Pin	2	46	Pawl Retaining Pin	1
15	Rotor	1	47	Spring	2
16	Rotor Blade	4	48	Steel Ball	2
17	Cylinder	1	49	Thrust Washer	1
● 18	Spring Pin	1	50	Retainer	1
★ 19	Front End Plate Assembly { incl.14 (1).18 }	1	51	Wave Washer	1
20	Ball Bearing	1	● 52	Rear Rotor Bearing Shield	1
● 23	Pin	3	● 53	Power Regulator	1
24	Ring Gear	1	● 54	O-Ring	1
25	Planet Gear	3	● 55	Steel Ball	1
★ 26	Work Spindle Assembly { incl.23 (3) }	1	● 56	Spring	1
● 27	Bushing	1	TK	Tune-Up Kit { incl.5.6.16 (4).44.47.48 }	

★ Must be Purchased in Assembly Set

● Recommended not to be purchased alone due to assembly difficulty

20150414R1