

SUPER DUTY VIBRATION-DAMPED AIR PITTSBURGH LOCK HAMMER

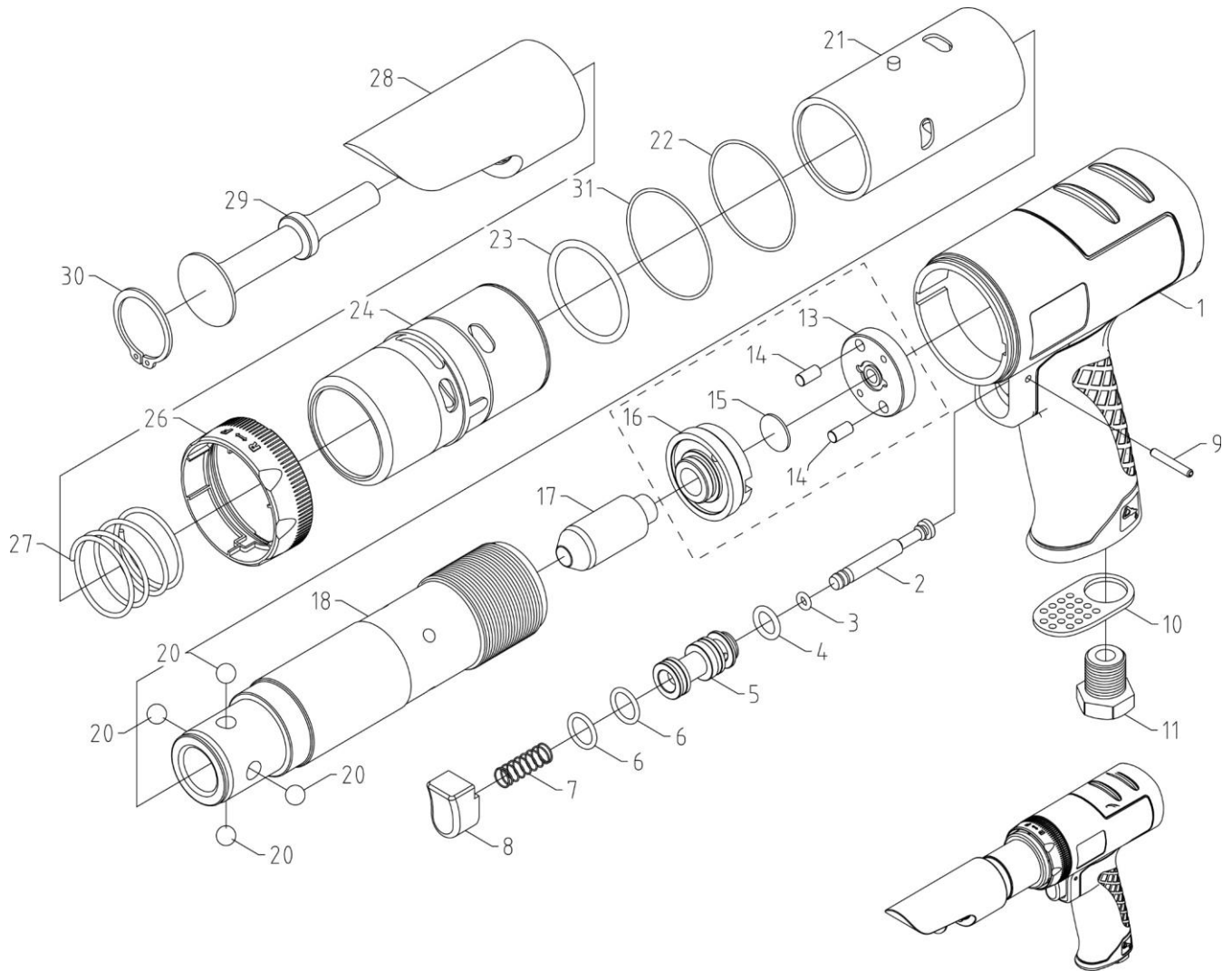

4777-PH

INDEX NO.	DESCRIPTION	REQ'D NO.	INDEX NO.	DESCRIPTION	REQ'D NO.
01	Housing	1	17	Piston	1
02	Valve Stem	1	18	Cylinder (Round)	1
03	O-Ring	1	20	Steel Ball (5/16")	4
04	O-Ring	1	21	Exhaust Sleeve	1
05	Valve Bushing	1	22	O-Ring	1
06	O-Ring	2	23	O-Ring	1
07	Valve Spring	1	24	Exhaust Guide	1
08	Button	1	26	Switchable Front Cap	1
09	Spring Pin	1	27	Compression Spring	1
10	Exhaust Deflector	1	28	Guide	1
11	Inlet Bushing (1/4")	1	29	Driver	1
13	Upper Valve Case	1	30	Snap Ring	1
14	Dowel Pin	2	31	O-Ring	1
15	Valve	1	TK1	Valve Kit (13,14x2,15,16) (Option)	1set
16	Lower Valve Case	1			

0000.00.00

2016.05.11 2016.07.18